

PowerRACK™
Rack Mount Power Distribution

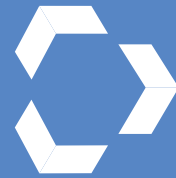

Enclosed Rack Mount Power Distribution

ETL Listed Power for Permanent and
Rolling Rack Use



LEX

WE DELIVER THE POWER™



Enclosed Rack Mount Power Distribution Modules: Innovative Solutions for the Entertainment Production Industry

Lex Products' PowerRACK™ Enclosed Rack Mount Power Distribution modules allow convenience receptacles to be added to standard EIA (Electronics Industries Alliance) 19-inch permanent or portable racks. Modules are ETL Listed to UL Standards and are available in 1, 2 and 3 rack unit heights.



Nineteen different configurations offer many input and output options, and make the modules exceptionally flexible for shifting power requirements. Typical applications include powering audio and lighting equipment.

Features & Benefits





- Product range includes a variety of connectors to meet the changing needs of entertainment venues, including Neutrik powerCONs for the growing use of LED lights
- ETL Listed for US and Canada, tested to UL Standards
- Aluminum construction with anodized finish is lightweight for portability and durability, while ensuring years of service
- Modules are fully enclosed for easy handling and installation
- Indicator lights and laser etched labels enable easy circuit identification
- Suitable for Lex Products' PowerRACK™ Rolling Distribution Racks or any standard 19" rack, permanent or portable





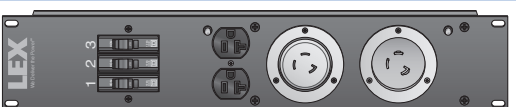

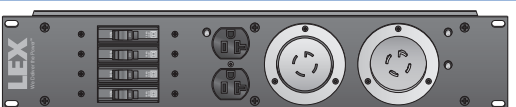

Enclosed Rack Modules - 1RU

View	Part Number	Input	Output	Overcurrent Protection	# Circuits	
Front	PRM1UN-8CA		Front: 2 x 20 Amp powerCON, In/Thru	Rear: 6 x NEMA 5-15, 15 Amp receptacles; Front: 2 x NEMA 5-15, 15 Amp receptacles	Front: 1 x 15 Amp	1
Rear						
Front	PRM1TN-6CA		Rear: 1 x 20 Amp powerCON, In	Rear: 6 x NEMA 5-15, 15 Amp receptacles	Front: 1 x 15 Amp	1
Rear						
Front	PRM1TNTN-8CA		Rear: 2 x 20 Amp powerCON, In	Rear: 8 x NEMA 5-15, 15 Amp receptacles	Front: 2 x 15 Amp	2
Rear						

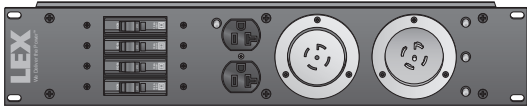
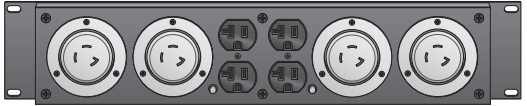

Enclosed Rack Modules - 2RU

View	Part Number	Input	Output	Overcurrent Protection	# Circuits	
Front	PRM2IC-9CC		Front: NEMA L5-30, 30 Amp locking, In/Thru	Rear: 8 x NEMA 5-20, 20 Amp duplex; Front: 1 x NEMA 5-20, 20 Amp duplex	Front: 3 x 20 Amp	3
Rear						
Front	PRM2IJ-5CC2DC		Front: NEMA L14-30, 30 Amp locking, In/Thru	Rear: 2 x NEMA L5-30, 30 Amp locking, 4 x NEMA 5-20, 20 Amp duplex; Front: 1 x NEMA 5-20, 20 Amp duplex	Front: 2 x 30 Amp, 2 x 20 Amp	4
Rear						
Front	PRM2IJ-3CC4DC		Front: NEMA L14-30, 30 Amp locking, In/Thru	Rear: 4 x NEMA L5-30, 30 Amp locking, 2 x NEMA 5-20, 20 Amp duplex; Front: 1x NEMA 5-20, 20 Amp duplex	Front: 2 x 30 Amp, 2 x 20 Amp	4
Rear						
Front	PRM2IN-7CC		Front: NEMA L21-30, 30 Amp locking, In/Thru	Rear: 6 x NEMA 5-20, 20 Amp duplex; Front: 1 x NEMA 5-20, 20 Amp duplex	Front: 3 x 20 Amp	3
Rear						

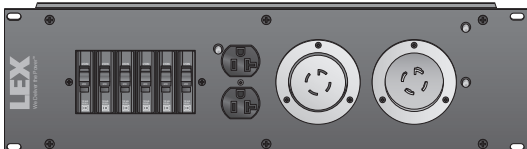

Enclosed Rack Modules - 2RU (continued)

View	Part Number	Input	Output	Overcurrent Protection	# Circuits
Front  Rear 	PRM2IN-9CC	Front: NEMA L21-30, 30 Amp locking, In/Thru	Rear: 8 x NEMA 5-20, 20 Amp duplex; Front: 1 x NEMA 5-20, 20 Amp duplex	Front: 3 x 20 Amp	3
Front  Rear 	PRM2IN-5CC2DC	Front: NEMA L21-30, 30 Amp locking, In/Thru	Rear: 2 x NEMA L5-30, 30 Amp locking, 4 x NEMA 5-20, 20 Amp duplex; Front: 1 x NEMA 5-20, 20 Amp duplex	Front: 2 x 30 Amp, 2 x 20 Amp	4
Front  Rear 	PRM2IN-3CC4DC	Front: NEMA L21-30, 30 Amp locking, In/Thru	Rear: 4 x NEMA L5-30, 30 Amp locking, 2 x NEMA 5-20, 20 Amp duplex; Front: 1 x NEMA 5-20, 20 Amp duplex	Front: 2 x 30 Amp, 2 x 20 Amp	4
Front  Rear 	PRM2IN-1CC12GN	Front: NEMA L21-30, 30 Amp locking, In/Thru	Rear: 12 x 20 Amp powerCON; Front: 1 x NEMA 5-20, 20 Amp duplex	Front: 3 x 20 Amp	3

Enclosed Rack Modules - 3RU

View	Part Number	Input	Output	Overcurrent Protection	# Circuits
Front  Rear 	PRM3IJ-9CC	Front: NEMA L14-30, 30 Amp locking, In/Thru	Rear: 8 x NEMA 5-20, 20 Amp duplex; Front: 1 x NEMA 5-20, 20 Amp duplex	Front: 6 x 20 Amp	6

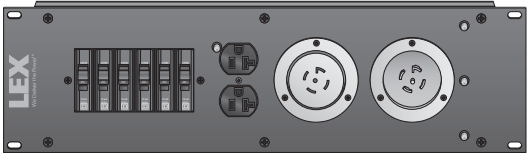
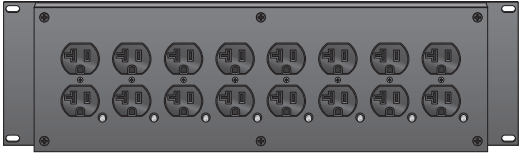
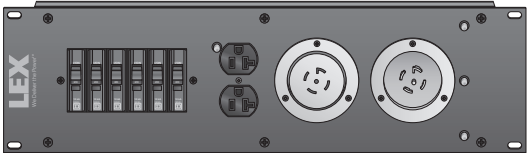
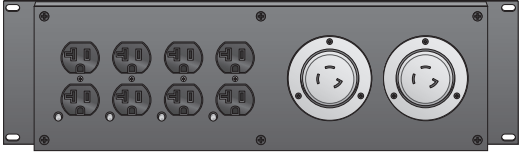
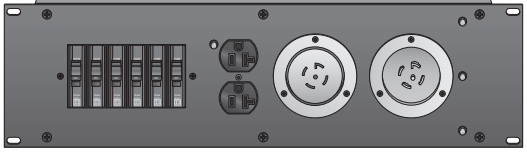
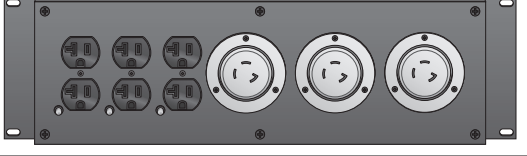
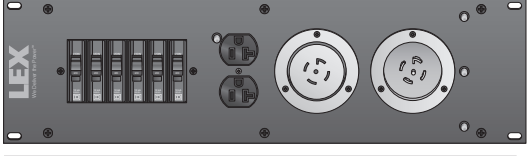
Enclosed Rack Modules - 3RU (continued)

View	Part Number	Input	Output	Overcurrent Protection	# Circuits
Front  Rear 	PRM3IN-9CC	Front: NEMA L21-30, 30 Amp locking, In/Thru	Rear: 8 x NEMA 5-20, 20 Amp duplex; Front: 1 x NEMA 5-20, 20 Amp duplex	Front: 6 x 20 Amp	6
Front  Rear 	PRM3IN-5CC2DC	Front: NEMA L21-30, 30 Amp locking, In/Thru	Rear: 2 x NEMA L5-30, 30 Amp locking, 4 x NEMA 5-20, 20 Amp duplex; Front: 1 x NEMA 5-20, 20 Amp duplex	Front: 2 x 30 Amp, 4 x 20 Amp	6
Front  Rear 	PRM3IN-4CC3DC	Front: NEMA L21-30, 30 Amp locking, In/Thru	Rear: 3 x NEMA L5-30, 30 Amp locking, 3 x NEMA 5-20, 20 Amp duplex; Front: 1 x NEMA 5-20, 20 Amp duplex	Front: 3 x 30 Amp, 3 x 20 Amp	6
Front  Rear 	PRM3IN-3CC4DC	Front: NEMA L21-30, 30 Amp locking, In/Thru	Rear: 4 x NEMA L5-30, 30 Amp locking, 2 x NEMA 5-20, 20 Amp duplex; Front: 1 x NEMA 5-20, 20 Amp duplex	Front: 4 x 30 Amp, 2 x 20 Amp	6

Enclosed Racks Modules - 3RU (continued)

View	Part Number	Input	Output	Overcurrent Protection	# Circuits
Front Rear	PRM3IN-1CC6DC	Front: NEMA L21-30, 30 Amp locking, In/Thru	Rear: 6 x NEMA L5-30, 30 Amp locking; Front: 1 x NEMA 5-20, 20 Amp duplex	Front: 5 x 30 Amp, 1 x 20 Amp	6
Front Rear	PRM3IN-1CC12GN	Front: NEMA L21-30, 30 Amp locking, In/Thru	Rear: 12 x 20 Amp Front: 1 x NEMA 5-20, 20 Amp duplex	Front: 6 x 20 Amp	6
Front Rear	PRM3KN-9CC	Front: CS63, 50 Amp, 125/250V locking, In/Thru	Rear: 8 x NEMA 5-20, 20 Amp duplex; Front: 1 x NEMA 5-20, 20 Amp duplex	Front: 6 x 20 Amp	6

Rack Accessories

Description	Part Number	Size
Vent panel	PRP1V	1RU
Blank panel	*Part Number PRPB1, PRPB2, PRPB3, PRPB4, PRPB5, PRPB6	1RU - 6RU

*Part number's last digit = RU height

PowerRACK™ Rolling Distribution Rack Enclosure

PowerRACK™
Rolling Distribution Racks



The Lex Products PowerRACK™ Rolling Distribution Rack is an ideal accompaniment for enclosed rack modules, due to the rack's nimbleness and durability.

Features & Benefits

- Available in a variety of sizes from 8RU to 28RU
- Lightweight, rugged aluminum frame
- Top, bottom and sides constructed from extremely durable high impact, high density polymer
- Recessed cups on top panel allow stacking for storage
- Recessed hardware helps prevent breakage and catching
- Front and back "snap-in" latches provide easy access without compromising protection
- No exposed latches when doors are removed
- Custom engraving can be routed into the top or side panels



Custom depths available



Custom engraving can be routed into top or sides and inset on laser engraved panels



"Snap-in" latches for easy access and closure



Roadworthy rolling rack construction features high-density panels with recessed hardware and aluminum frame

PowerRACK™

ETL Listed Power for Permanent and Rolling Rack Use



Lex Products
15 Progress Drive
Shelton CT 06484
203.363.3738
203.363.3742 Fax

Lex West
12701 Van Nuys Blvd
Suite Q
Pacoima, CA 91331
818.768.4474
818.768.4040 Fax

www.lexproducts.com
info@lexproducts.com
800.643.4460

© Copyright Lex Products 2020

Produced in the United States of America
All Rights Reserved.

Lex Products logo and lexproducts.com are
trademarks or registered trademarks of Lex Products
in the United States, other countries, or both.