

PowerRACK™
Rolling Distribution Racks

UL US LISTED



PowerRACK™ Rolling Distribution Racks

Ideal for Stage and Studio



SLAM Solutions

Atención en español para todo Latinoamérica
www.corpslam.com informes@corpslam.com
WhatsApp +52 55 5416 0517

- Innovative Rack Design
- Custom Panel Configurations
- Roadworthy Construction
- Custom Rack Engravings Available
- Custom Built to Specifications



Popular PowerRACK™ Configurations

PowerRACK™
Rolling Distribution Racks

UL US LISTED

**In Stock & Ready
to Ship!!**



"Presidential" Rack

Part Number	PRMM18Q-2MR8U-X-LV
Rating	400A, 120/208VAC 3 Phase 4P 5W
Environmental Rating	TYPE 1 Indoor
Input	(1) Set of (5) 16 Series Cam-type panel mount Male Devices, Reverse Ground & Neutral
Feed Thru	Yes
Output	(8) 6-Circuit, 120V LSC19 receptacles (8) 6-Circuit, 208V LSC19 receptacles (parallel) (6) L21-30 receptacles
Enclosure	Extruded Aluminum frames combined with polyethylene (HDPE)
Dimensions	26" L x 24" W x 39.5" H



"Viceroy" Rack

Part Number	PRMK12D-MR4U-2LV
Rating	200A, 120/208VAC 3 Phase 4P 5W
Environmental Rating	TYPE 1 Indoor
Input	(5) 16 Series Cam-type panel mount Male devices, RGN
Feed Thru	Yes
Output	(4) 6-Circuit, 120V LSC19 receptacles (4) 6-Circuit, 208V LSC19 receptacles (parallel) (3) L21-30 Receptacles (6) 5-20 Duplex Receptacles
Enclosure	Extruded Aluminum frames combined with polyethylene (HDPE)
Dimensions	26" L x 24" W x 30" H

Custom built to your specification

PowerRACK™
Rolling Distribution Racks



Lex Products PowerRack™ Rolling Distribution Racks are custom configured to meet the needs of specific applications. Ideal for touring applications where power requirements change frequently, these high-quality, durable racks can feature a range of input, output and circuit breaker options. Custom rack sizes and engraved labels are available also.



"Snap-in" latches allow quick access and closure.



Custom artwork can be routed into high density polymer top or inset on laser engraved panels.



Custom circuit numbering and logos on rack panels are available. Custom, state-of-the-art laser engraving is completed in-house. All panels have standard engraving for sequential device numbering, power ratings and safety notices.



Roadworthy rolling rack construction features high-density panels with recessed hardware and aluminum frame.

PowerRACK™ Construction



cULus Listed Rolling Distribution Racks deliver remarkable strength, extreme durability and resistance to corrosion, scratching and denting

19" Power Distribution Panel Features:

- Constructed of lightweight, anodized aluminum, standard 19" rack mount
- Laser engraved for clear and concise identification
- Wide selection of top quality NEMA, Pin & Sleeve, XLR, LSC19, Stage Pin and Cam-Type Single Pole devices
- 100% rated, electronic main and magnetic branch-rated circuit breakers
- LED power indicators include discrete 6-circuit arrays for LSC19 19-pin receptacles

Rolling Rack Features & Benefits:

- Lightweight, rugged aluminum frame.
- Available from 8RU to 28RU
- All hardware is recessed to protect against breakage and catching
- Front and back latches "snap-in" to provide easy access without compromising protection
- No exposed latches when doors are removed
- High impact, high density polymer top, bottom and sides
- Recessed cups on top panel for stacking
- Company logos may be routed into the top or side panels

Standard Colors:







Sandshade

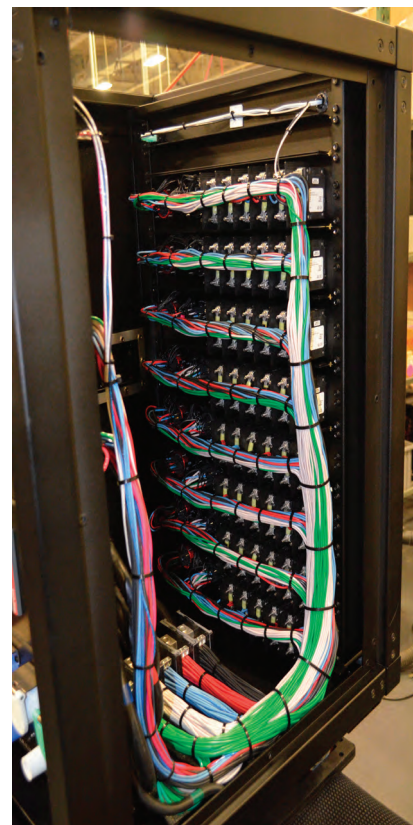
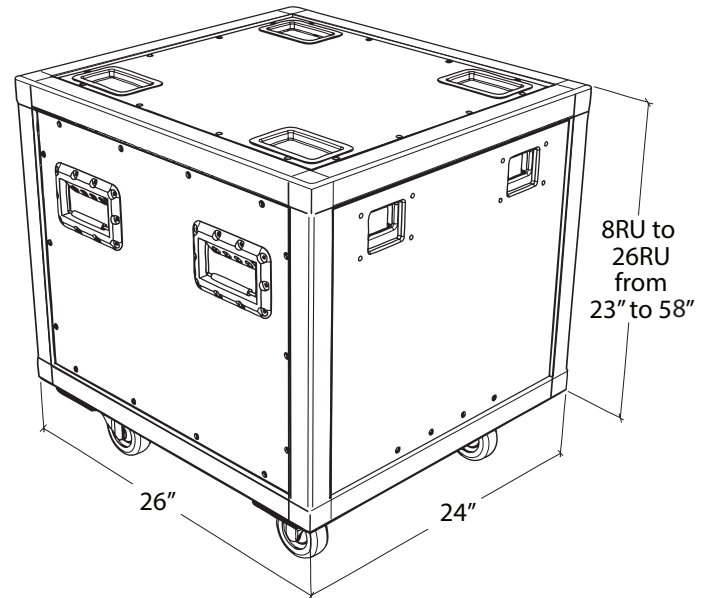

Black

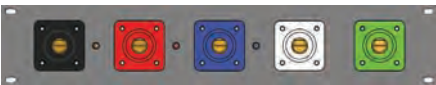

PowerRACK™ Input Panels





Panel	Size	Description	Catalog No.
	2RU	(5) wire 16 Series Cam-Type Male devices	PRP516C2 PRP516C2RGN*
	4RU	(5) wire 16 Series Cam-Type Male devices (5) wire 16 Series Cam-Type Female devices with NEMA 3R weather resistant covers	PRP1016C4 PRP1016C4RGN* PRP1016C4-VT** PRP1016C4RGN-VT†
	4RU	(5) wire 16 Series Cam-Type Male devices (5) wire 16 Series Cam-Type Female devices with NEMA 3R weather resistant covers 3 Phase, digital LED display line voltage monitoring	DCL400M
	2RU	(6) wire 16 Series Cam-Type Male devices (double neutral)	PRP616C2
	4RU	(6) wire 16 Series Cam-Type Male devices (double neutral) (6) wire 16 Series Cam-Type Female devices (double neutral) with NEMA 3R weather resistant covers	PRP1216C4 PRP1216C4-VT** PRP1216C4RGN-VT†

*Features reverse ground and neutral

**Features test ports















†Features reverse ground and neutral and test ports

PowerRACK™ Main Breaker Panels

Panel	Size	Description	Catalog No.
	3RU	100 Amp, 3 Pole, 600 VAC Electronic trip 100% rated	PRPM100
	3RU	200 Amp, 3 Pole, 600 VAC Electronic trip 100% rated	PRPM200
	4RU	400 Amp, 3 Pole, 600 VAC Electronic trip 100% rated	PRPM400
	3RU	160 Amp, 3 Phase to 240 Amp, Single Phase switchable interlocked breaker module	PD80LC
	3RU	200 Amp, 3 Phase to 300 Amp, Single Phase switchable interlocked breaker module	PD100LC
	3RU	250 Amp, 3 Phase to 375 Amp, Single Phase switchable interlocked breaker module	PD300LC

Interlock positively selects either single or three phase operation.

PowerRACK™ Branch-Rated Circuit Breaker Panels

Panel	Size	Description	Catalog No.
	2RU	(6) 20 Amp, Single Pole, Magnetic	PRP621P2
	2RU	(12) 20 Amp, Single Pole, Magnetic	PRP1221P2
	2RU	(6) 20 Amp, 2 Pole, Magnetic	PRP622P2
	3RU	(12) 20 Amp, 2 Pole, Magnetic	PRP1222P3
	2RU	(3) 30 Amp, 2 Pole, Magnetic	PRP332P2
	2RU	(6) 30 Amp, 2 Pole, Magnetic	PRP632P2
	2RU	(3) 50 Amp, 2 Pole, Magnetic	PRP352P2
	2RU	(6) 50 Amp, 2 Pole, Magnetic	PRP652P2
	2RU	(3) 20 Amp, 3 Pole, Magnetic	PRP323P2
	2RU	(6) 20 Amp, 3 Pole, Magnetic	PRP623P2
	2RU	(3) 30 Amp, 3 Pole, Magnetic	PRP333P2
	2RU	(6) 30 Amp, 3 Pole, Magnetic	PRP633P2
	2RU	(3) 50 Amp, 3 Pole, Magnetic	PRP353P2
	2RU	(6) 50 Amp, 3 Pole, Magnetic	PRP653P2



All circuit breakers 240 VAC maximum rating

PowerRACK™ Output Panels with Branch-Rated Circuit Breakers

Panel	Size	Description	Catalog No.
	2RU	(6) NEMA 5-20, 20 Amp, 2 Pole, 3 Wire, 120 VAC duplex receptacles (6) 20 Amp, Single Pole circuit breakers	PRP6PB61P2
	2RU	(6) 20 Amp, 2 Pole, 3 Wire, 240 VAC PowerCON connectors (6) 20 Amp, Single Pole circuit breakers	PRP6PC61P2
	2RU	(6) 20 Amp, 2 Pole, 3 Wire, 120 VAC stage pin receptacles (6) 20 Amp, Single Pole circuit breakers	PRP6SP61P2
	3RU	(6) NEMA L5-20, 20 Amp, 2 Pole, 3 Wire, 120 VAC locking receptacles (6) 20 Amp, Single Pole circuit breakers	PRP6L5261P3
	3RU	(6) NEMA L5-30, 30 Amp, 2 Pole, 3 Wire, 120 VAC locking receptacles (6) 30 Amp, Single Pole circuit breakers	PRP6L5361P3
	2RU	(1) 20 Amps per circuit, 6-circuit, 120 VAC LSC19 panel mount receptacle (1) NEMA 5-20, 20 Amp, 2 Pole, 3 Wire, 120 VAC duplex receptacle (7) 20 Amp, Single Pole circuit breakers	PRP1191PB71P2
	2RU	(2) 20 Amps per circuit, 6-circuit, 120 VAC LSC19 panel mount receptacles (wired in parallel) (1) NEMA 5-20, 20 Amp, 2 Pole, 3 Wire, 120 VAC duplex receptacle (7) 20 Amp, Single Pole circuit breakers	PRP2191PB71P2
	2RU	(2) 20 Amps per circuit, 6-circuit, 120 VAC LSC19 panel mount receptacles (12) 20 Amp, Single Pole circuit breakers	PRP219121P2
	2RU	(3) NEMA L6-20, 20 Amp, 2 Pole, 3 Wire, 240 VAC locking receptacles (3) 20 Amp, 2 Pole circuit breakers	PRP3L6232P2
	2RU	(3) NEMA L6-30, 30 Amp, 2 Pole, 3 Wire, 240 VAC locking receptacles (3) 30 Amp, 2 Pole circuit breakers	PRP3L6332P2
	3RU	(3) NEMA L14-20, 20 Amp, 3 Pole, 4 Wire, 120/240 VAC locking receptacles (3) 20 Amp, 2 Pole circuit breakers	PRP3L14232P3
	3RU	(3) NEMA L14-30, 30 Amp, 3 Pole, 4 Wire 120/240 VAC locking receptacles (3) 30 Amp, 2 Pole circuit breakers	PRP3L14332P3

All receptacles have LED indicators for power.

PowerRACK™ Output Panels with Branch-Rated Circuit Breakers – Continued

Panel	Size	Description	Catalog No.
	2RU	(1) 20 Amps per circuit, 6-circuit, 220 VAC, LSC19 panel mount receptacle (1) NEMA 5-20, 20 Amp, 2 Pole, 3 Wire, 120 VAC duplex receptacle (6) 20 Amp, 2 Pole circuit breakers (1) 20 Amp, Single Pole circuit breaker	PRP11962P2
	2RU	(1) 20 Amp per circuit, 6-circuit, 120 VAC LSC19 Panel Mount Receptacle (1) 20 Amp per circuit, 6-circuit, 220 VAC LSC19 Panel Mount (Wired in Parallel) (6) 20 Amp, 2 Pole circuit breakers	PRP221962P2
	2RU	(2) 20 Amps per circuit, 6-circuit, 220 VAC, LSC19 panel mount receptacles (wired in parallel) (6) 20 Amp, 2 Pole circuit breakers	PRP21962P2
	3RU	(3) NEMA L15-20, 20 Amp, 3 Phase, 3 Pole, 4 Wire, 240 VAC locking receptacles (3) 20 Amp, 3 Pole circuit breakers	PRP3L15233P3
	3RU	(3) NEMA L15-30, 30 Amp, 3 Phase, 3 Pole, 4 Wire, 240 VAC locking receptacles (3) 30 Amp, 3 Pole circuit breakers	PRP3L15333P3
	3RU	(3) NEMA L21-20, 20 Amp, 3 Phase, 4 Pole, 5 Wire, 120/208Y VAC locking receptacles (3) 20 Amp, 3 Pole circuit breakers	PRP3L21233P3
	3RU	(3) NEMA L21-30, 30 Amp, 3 Phase, 4 Pole, 5 Wire, 120/208Y VAC locking receptacles (3) 30 Amp, 3 Pole circuit breakers	PRP3L21333P3
	3RU	(3) 50 Amp, 3 Pole, 4 Wire, 120/240 VAC California-Style locking receptacles (3) 50 Amp, 2 Pole circuit breakers	PRP35012532P3
	3RU	(3) 50 Amp, 3 Phase, 3 Pole, 4 Wire, 240 VAC California-style locking receptacles (3) 50 Amp, 3 Pole circuit breakers	PRP35025033P3

All receptacles have LED indicators for power.

PowerRACK™ Output Panels (No Circuit Breakers)

Panel	Size	Description	Catalog No.
	1RU	(3) NEMA 5-20, 20 Amp, 2 Pole, 3 Wire, 120 VAC duplex receptacles	PRP3PB1
	2RU	(6) NEMA 5-20, 20 Amp, 2 Pole, 3 Wire, 120 VAC duplex receptacles	PRP6PB2
	2RU	(6) 20 Amp, 2 Pole, 3 Wire, 120 VAC stage pin receptacles	PRP6SP2
	3RU	(12) 20 Amp, 2 Pole, 3 Wire, 120 VAC stage pin receptacles	PRP12SP3
	2RU	(6) NEMA L5-20, 20 Amp, 2 Pole, 3 Wire, 120 VAC locking receptacles	PRP6L522
	2RU	(6) NEMA L5-30, 30 Amp, 2 Pole, 3 Wire, 120 VAC locking receptacles	PRP6L532
	2RU	(4) 20 Amps per circuit, 6-circuit, 120 VAC, LSC19 panel mount receptacles	PRP4192
	2RU	(4) 20 Amps per circuit, 6-circuit, 220 VAC, LSC19 panel mount receptacles	PRP41922
	2RU	(6) NEMA L6-20, 20 Amp, 2 Pole, 3 Wire, 240 VAC locking receptacles	PRP6L622
	2RU	(6) NEMA L6-30, 30 Amp, 2 Pole, 3 Wire, 240 VAC locking receptacles	PRP6L632
	3RU	(6) NEMA L14-20, 20 Amp, 3 Pole, 4 Wire, 120/240 VAC locking receptacles	PRP6L1423
	3RU	(6) NEMA L15-20, 20 Amp, 3 Phase, 3 Pole, 4 Wire, 240 VAC locking receptacles	PRP6L1523
	3RU	(6) NEMA L15-30, 30 Amp, 3 Phase, 3 Pole, 4 Wire, 240 VAC locking receptacles	PRP6L1533







All receptacles have LED indicators for power.

PowerRACK™ Output Panels (No Circuit Breakers) – Continued

Panel	Size	Description	Catalog No.
	3RU	(6) NEMA L21-20, 20 Amp, 3 Phase, 4 Pole, 5 Wire, 120/208Y VAC locking receptacles	PRP6L2123
	3RU	(6) NEMA L21-30, 30 Amp, 3 Phase, 4 Pole, 5 Wire, 120/208Y VAC locking receptacles	PRP6L2133
	3RU	(4) 50 Amp, 3 Pole, 4 Wire, 120/240 VAC California-Style locking receptacles	PRP4501253
	3RU	(4) 50 Amp, 3 Phase, 3 Pole, 4 Wire, 240 VAC California-Style locking receptacles	PRP4502503
	4RU	(3) 32 Amp, 3 Pole, 4 Wire, 380-415 VAC pin & sleeve receptacles Red (European Systems)	PRP3432R4
	4RU	(3) 32 Amp, 4 Pole, 5 Wire, 240/415 VAC pin & sleeve receptacles Blue (European Systems)	PRP3532B4

LED indicators included on all panels for receptacles.

PowerRACK™ Meter and Accessory Panels

Panel	Size	Description	Catalog No.
	1RU	3 Phase, digital LED display line voltage and amperage monitoring	VA3MA
	1RU	3 Phase, digital LED display line and neutral voltage and amperage monitoring	VA4MA
	1RU	Vent panel	PRP1V
	1-6RU	Blank panels	PRPB1, PRPB2, PRPB3, PRPB4, PRPB5, PRPB6
	1RU	1 In 8 Out, DMX isolator splitter/repeater module	ISR1.8
	1RU	Rack LED light	PRPLED1

PowerRACK™ Sizes



Lex Products Rolling Distribution Racks are available in a range of sizes to suit the needs of specific applications. All racks are 26" deep and can be custom configured from 8RU to 26RU. These high quality, durable rolling racks are designed to fit all standard 19" rack mount modules.

RU	Height	26" Deep Catalog No.
8	23.00	PRRMF-0826
10	26.50	PRRMF-1026
12	30.00	PRRMF-1226
14	33.50	PRRMF-1426
16	37.00	PRRMF-1626
18	40.50	PRRMF-1826
20	44.00	PRRMF-2026
22	47.50	PRRMF-2226
24	51.00	PRRMF-2426
26	54.50	PRRMF-2626

All racks are 24" wide. Measurements are in inches. Custom heights and depths are available upon request.

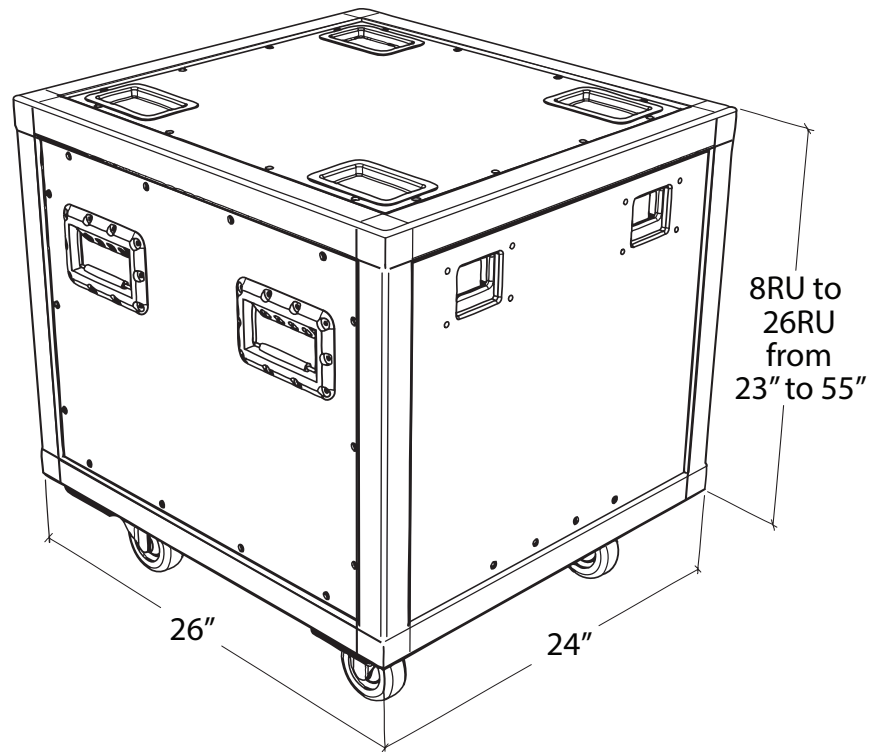

Rack Specifications

1. Rack shall be constructed using vertical and horizontal rails of extruded 5052-H32 aluminum.
2. Finish shall be powder-coat black.
3. Corners shall be cast GB Aluminum 102 Alloy.
4. Rack rail shall be constructed for mounting of 19" wide (482.6 mm) rack panels in vertical configurations according to EIA standard rack unit spacing of 1U = 1.75" (44.45 mm).
5. Rack frame shall be constructed to accommodate machined, 1/2" and 3/4" high density polymer panels (HDPE). These panels shall be affixed to the frame in the top, bottom and two side positions.
6. Casters shall be 3 1/2" (89 mm), 250 lb. (113 kg) capacity with a swivel radius of 2.906" (73.8 mm).

Panel Specifications

1. Panels shall be fabricated from 0.090" Aluminum.
2. Finish shall be anodized black.
3. Panel top and bottom edges shall be flanged 1.00".
4. Panels shall be punched to accommodate NEMA, XLR, Cam-Type Single Pole, Pin & Sleeve, LSC19 and Stage Pin devices, LED indicators as well as digital meters.
5. Panels shall be laser engraved with device sequence numbering, input/output power ratings, power connection instructions and safety warnings.

SLAM Solutions
Atención en español para todo Latinoamérica
www.corpslam.com
informes@corpslam.com
WhatsApp +52 55 5416 0517



Lex Products
11 Forest Parkway
Shelton CT 06484
203.363.3738
203.363.3742 Fax

Lex South
15751 41 SW Street
Suite 300
Davie, FL 33331
954.888.1024
954.888.1026 Fax

Lex West
12701 Van Nuys Blvd
Suite Q
Pacoima, CA 91331
818.768.4474
818.768.4040 Fax

www.lexproducts.com
info@lexproducts.com
800.643.4460

© Copyright Lex Products 2020

Produced in the United States of America
05-30 All Rights Reserved.

Lex Products logo and lexproducts.com are trademarks
or registered trademarks of Lex Products in the United
States, other countries, or both.